



DATE January 8, 2020

No. V-70107C-E

Messrs. \_\_\_\_\_

# SPECIFICATION

\_\_\_\_\_  
Semiconductor Pressure Sensor

Model: AL4 series (Gauge Pressure Type)

Project: \_\_\_\_\_

Distributor: \_\_\_\_\_

Reference: \_\_\_\_\_

A handwritten signature in black ink, appearing to read 'Y. Uchiyama', is written over a horizontal line.

\_\_\_\_\_  
Yoshiyuki Uchiyama, Application Engineer  
Sensor Business Unit  
Electronic Component Business Company  
Fujikura Ltd.

## Fujikura Ltd.

## Table of Contents

- 1. General.....2
- 2. Principle .....2
- 3. Device Lineup.....2
- 4. RoHS.....2
- 5. Block Diagram and Pin Connections.....3
- 6. Device Name Code .....4
- 7. Absolute Maximum Ratings .....4
- 8. Environmental Specifications.....4
- 9. Pressure Specifications .....5
- 10. Electrical Characteristics .....6
- 11. Electrical Characteristics for I<sup>2</sup>C or SPI Interface .....7
- 12. I<sup>2</sup>C or SPI Circuits (Reference) .....7
- 13. I<sup>2</sup>C Digital Interface .....8
- 14. I<sup>2</sup>C Communication Protocol.....8
- 15. SPI Digital Interface.....9
- 16. SPI Communication Protocol.....9
- 17. Output versus Input Pressure .....10
- 18. Transfer Function .....11
- 19. Device Marking .....12
- 20. Soldering .....12
- 21. Dimensions and Weights.....12
- 22. Ordering Information .....13
- 23. Tape & Reel Information .....13
- 24. Handling Notes.....13
- 25. Notes.....13
- Appendix: Dimension Drawing .....14
  - 9-772-006 ALxxDB .....14

**Table shown below is revision records of this specification**

Rev. 3	Jan. 8, 2020	Y. Uchiumi	Added Environmental Specifications and Pressure Specifications Removed General Specifications Changed quantity per reel Changed Error1: $\pm 1.5\%FS \rightarrow \pm 1.0\%FS$ and Error2 deleted in Electrical Specifications	C
Rev. 2	Feb. 13, 2019	Y. Uchiumi	Typo correction on 23. Ordering Information. Improved Operating & Storage Humidity specs.	B
Rev. 1	Jan. 23, 2019	Y. Uchiumi	Height changed	A
Est.	Nov. 5, 2018	Y. Uchiumi	Issued	
	Date	Name	Comment	Mark

AL4 series (Gauge Pressure Type) | V-70107C-E

**1. General**

This document describes the specifications of the AL4 pressure sensors for gauge pressure type.

**2. Principle**

Fujikura Pressure Sensor is composed of a silicon piezo-resistive pressure sensing chip and a signal conditioning integrated circuit. The low-level signal from the sensing chip is amplified, temperature compensated, calibrated, and finally converted to digital data that is proportional to the applied pressure.

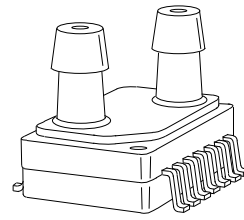

**3. Device Lineup**

This device has the following lineup.

Model	Pressure Type	Supply Voltage	Accuracy	Pressure Range																				
				-10 (-100)	-7 (-70)	-4 (-40)	-2 (-20)	-1 (-10)	0	1 (10)	2 (20)	4 (40)	7 (70)	10 kPa (100) cmH <sub>2</sub> O										
AL4	Gauge	5.0 Vdc 3.3 Vdc 3.0 Vdc	±1.5%FS							002KG														
											004KG													
													007KG											
														010KG										
												002KV												
												004KV												
													007KV											
														010KV										
															001KW									
																002KW								

**Features**

- ✓ Digital output
- ✓ Low pressure
- ✓ High proof pressure
- ✓ Moisture sensitivity level (MSL) 1
- ✓ Low power consumption
- ✓ High accuracy
- ✓ Modification available

**Applications**

- ✓ Battery-operated devices
- ✓ Medical devices
- ✓ Industrial pneumatic devices
- ✓ Consumer devices

**4. RoHS**

This device is compliant with the Restriction of the use of certain Hazardous Substances in Electrical and Electronic Equipment (RoHS).

5. Block Diagram and Pin Connections

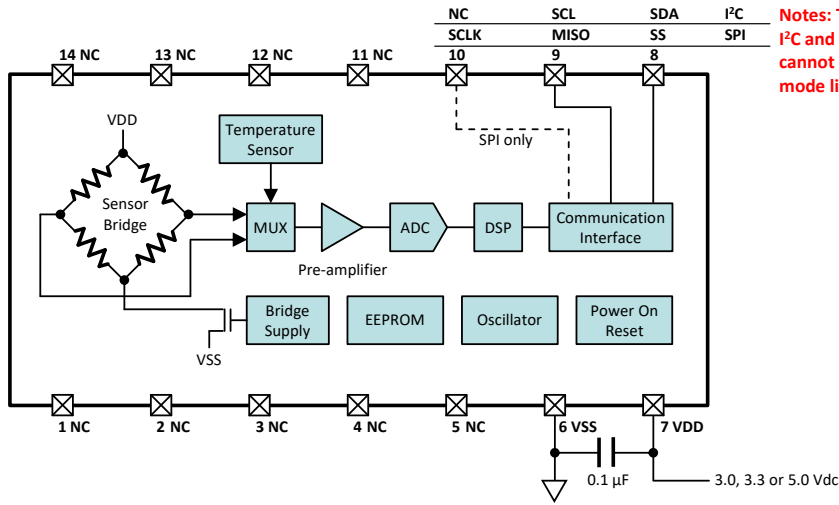

Notes: The internal connection of I<sup>2</sup>C and SPI is different. User cannot change communication mode like I<sup>2</sup>C to SPI or SPI to I<sup>2</sup>C.

Pin Assignment	Pin No.	Pin Name	I/O	Type	Function	
	1	NC	-	-	Non-connection	*3
	2	NC	-	-	Non-connection	*3
	3	NC	-	-	Non-connection	*3
	4	NC	-	-	Non-connection	*3
	5	NC	-	-	Non-connection	*3
	6	VSS	-	-	Common voltage connection	*1
	7	VDD	-	-	Power supply connection	*1
	8	I <sup>2</sup> C SDA	I/O	Digital	Serial bidirectional data	*2
		SPI SS	I	Digital	Slave select	
	9	I <sup>2</sup> C SCL	I	Digital	Serial clock input	*2
		SPI MISO	O	Digital	Master-In-Slave-Out	
	10	I <sup>2</sup> C NC	-	-	Non-connection	*2
		SPI SCLK	I	Digital	Serial clock input	
	11	NC	-	-	Non-connection	*3
12	NC	-	-	Non-connection	*3	
13	NC	-	-	Non-connection	*3	
14	NC	-	-	Non-connection	*3	

Notes:

- \*1) Put a 0.1μF capacitor between VDD Pin 7 and VSS.
- \*2) I<sup>2</sup>C or SPI is factory setting. User cannot change communication mode.
- \*3) NC pins must be open.

## AL4 series (Gauge Pressure Type) | V-70107C-E

## 6. Device Name Code

The device name code is consisted of Sensor code, Pressure code, Slave address code and Packing style. For the exact ordering device number, please refer to Chapter 22 Ordering Information.

Sensor code		Pressure code		Packing		TP: Tape & Reel	
AL4	1 DB	-	007K G	-	2	-	TP
Custom ID						if applicable	
Communication code						S: SPI mode	
						2: 0x28	
						3: 0x38	
						4: 0x48	
						5: 0x58	
						6: 0x68	
						7: 0x78	
						Slave address for I <sup>2</sup> C mode	
Pressure type		G: Gauge   Positive		V: Gauge   Negative		W: Gauge   Compound	
002KG:		0 kPa to +2 kPa		002KV:		-2 kPa to 0 kPa	
004KG:		0 kPa to +4 kPa		004KV:		-4 kPa to 0 kPa	
007KG:		0 kPa to +7 kPa		007KV:		-7 kPa to 0 kPa	
010KG:		0 kPa to +10 kPa		010KV:		-10 kPa to 0 kPa	
001KW:		-1 kPa to +1 kPa		002KW:		-2 kPa to +2 kPa	
004KW:		-4 kPa to +4 kPa		004KW:		-4 kPa to +4 kPa	
007KW:		-7 kPa to +7 kPa		007KW:		-7 kPa to +7 kPa	
010KW:		-10 kPa to +10 kPa		010KW:		-10 kPa to +10 kPa	
Pressure range							
Port option						DB: Dual axial barbed ports 	
						0: 5.0 Vdc	
						1: 3.3 Vdc	
						2: 3.0 Vdc	
Supply voltage							
Model						AL4: Low pressure   SMD   Digital output	

### Pressure Range Conversion (Reference)

Pressure Code	kPa	mbar	cmH <sub>2</sub> O	inchH <sub>2</sub> O	psi	mmHg
002KG	0 - +2	0 - +20	0 - +20.3943	0 - +8.03729	0 - +0.290075	0 - +15.0012
004KG	0 - +4	0 - +40	0 - +40.7886	0 - +16.0746	0 - +0.580151	0 - +30.0025
007KG	0 - +7	0 - +70	0 - +71.3801	0 - +28.1305	0 - +1.01526	0 - +52.5043
010KG	0 - +10	0 - +100	0 - +101.972	0 - +40.1865	0 - +1.45038	0 - +75.0062
002KV	-2 - 0	-20 - 0	-20.3943 - 0	-8.03729 - 0	-0.290075 - 0	-15.0012 - 0
004KV	-4 - 0	-40 - 0	-40.7886 - 0	-16.0746 - 0	-0.580151 - 0	-30.0025 - 0
007KV	-7 - 0	-70 - 0	-71.3801 - 0	-28.1305 - 0	-1.01526 - 0	-52.5043 - 0
010KV	-10 - 0	-100 - 0	-101.972 - 0	-40.1865 - 0	-1.45038 - 0	-75.0062 - 0
001KW	-1 - +1	-10 - +10	-10.1972 - +10.1972	-4.01865 - +4.01865	-0.145038 - +0.145038	-7.50062 - +7.50062
002KW	-2 - +2	-20 - +20	-20.3943 - +20.3943	-8.03729 - +8.03729	-0.290075 - +0.290075	-15.0012 - +15.0012
004KW	-4 - +4	-40 - +40	-40.7886 - +40.7886	-16.0746 - +16.0746	-0.580151 - +0.580151	-30.0025 - +30.0025
007KW	-7 - +7	-70 - +70	-71.3801 - +71.3801	-28.1305 - +28.1305	-1.01526 - +1.01526	-52.5043 - +52.5043
010KW	-10 - +10	-100 - +100	-101.972 - +101.972	-40.1865 - +40.1865	-1.45038 - +1.45038	-75.0062 - +75.0062

Note:

- \*1) The device is calibrated based on the unit of "kPa". Other converted pressure values are for reference.

## 7. Absolute Maximum Ratings

Item	Condition	Symbol	Rating		Unit
			Min.	Max.	
Supply Voltage		VDD <sub>max</sub>	-0.3	6	Vdc
Voltage at Digital I/O pins		V <sub>diomax</sub>	-0.3	VDD+0.3	Vdc
Operating Temperature		T <sub>opt</sub>	-40	+85	°C
Storage Temperature		T <sub>stg</sub>	-40	+85	°C

Notes:

- \*1) Absolute maximum ratings are the limits that the device will withstand without damage.

## 8. Environmental Specifications

Item	Condition	Symbol	Rating			Unit
			Min.	Typ.	Max.	
Operating Humidity	Non-condensing, +65°C		-	-	95	%RH *1, 2
Storage Humidity	Non-condensing, +65°C		-	-	95	%RH *1, 2

Notes:

- \*1) Do not wet the device with dew.  
 \*2) If the device is operated or storage at above +65°C in 95%RH, accuracy of the output is subject to be out of the specifications.

## 9. Pressure Specifications

Type of Pressure	Gauge pressure	*1
Pressure Media	Non-corrosive gases for wetted materials	*2, 3

Notes:

- \*1) gauge pressure is defined as the difference between the pressure applied to Port A and atmospheric pressure applied to Port B. See below figure.
- \*2) Wetted materials are PPS resin, silicone resin, silicon, gold, Cu alloy and silver.
- \*3) Ensure the pressure media contains no particulates. The device is not compatible with liquids.

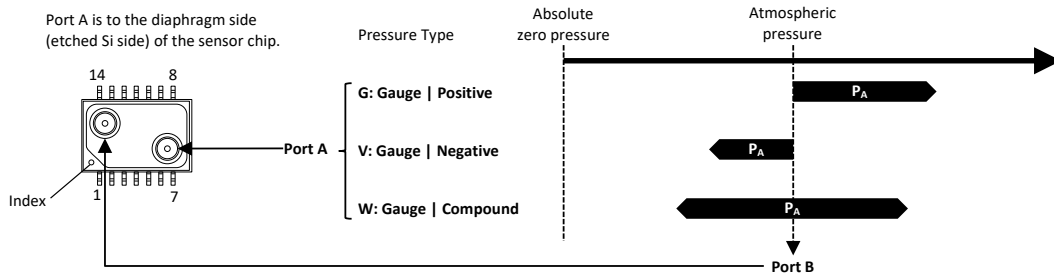

Pressure Table

Pressure Code	Item Symbol	Pressure Range *1		Proof Pressure *2	Burst Pressure *3	Unit
		Min. $P_{opt}$	Max. $P_{opt}$	$P_{max}$	$P_{burst}$	
002KG		0	+2	+100	+100	kPa
004KG		0	+4	+100	+100	kPa
007KG		0	+7	+100	+100	kPa
010KG		0	+10	+100	+100	kPa
002KV		-2	0	+100	+100	kPa
004KV		-4	0	+100	+100	kPa
007KV		-7	0	+100	+100	kPa
010KV		-10	0	+100	+100	kPa
001KW		-1	+1	+100	+100	kPa
002KW		-2	+2	+100	+100	kPa
004KW		-4	+4	+100	+100	kPa
007KW		-7	+7	+100	+100	kPa
010KW		-10	+10	+100	+100	kPa

Notes:

- \*1) In Pressure Range( $P_{opt}$ ), the output is proportional to difference between the pressure applied to Port A and Port B, meeting the specified accuracy.
- \*2) Proof Pressure( $P_{max}$ ) is defined as maximum applied pressure to the device without damage.
- \*3) The device will be damaged, if applied pressure is beyond Burst Pressure( $P_{burst}$ ).

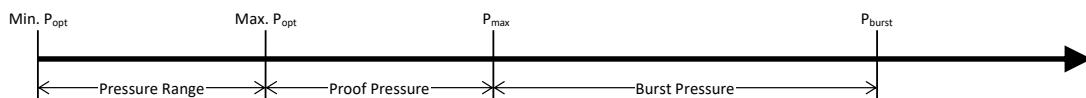

### Pressure Port Connection

#### Recommended Tube (Reference)

Flexible tubing is recommended. The following tubing is for reference. Please select appropriate tubing considering material, Durometer hardness and maximum pressure. Manifold connection can also be available with O-ring or sealing fixtures.

Unit	I.D.	O.D.	Wall thickness
inch	3/32	7/32	1/16
mm	2	4	1

#### Manifold Connection (Reference)

Manifold connection can also be available with O-ring or sealing fixtures. There are parting lines on the surface of the pressure port at the base side. Top part of the pressure port (barbed part) is recommended for sealing with fixtures.

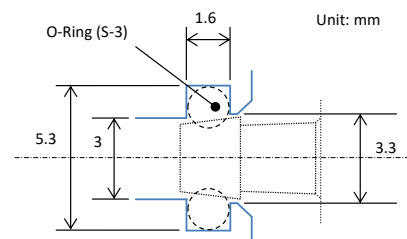

## 10. Electrical Characteristics

Ambient temperature  $T_a=25^\circ\text{C}$

Item	Condition		Symbol	Rating			Unit	
				Min.	Typ.	Max.		
Supply Voltage	Sensor Code	AL40DB	VDD	4.75	5	5.25	Vdc	*1
		AL41DB		3.135	3.3	3.465		
		AL42DB		2.85	3.0	3.15		
Offset Pressure Data	Pressure type	G/W: Min. $P_{opt}$	$D_{off}$	598	819	1040	Count	*2, 3
		V: Max. $P_{opt}$						
Full Scale Pressure Data	Pressure type	G/W: Max. $P_{opt}$	$D_{fs}$	15344	15565	15786	Count	*4
		V: Min. $P_{opt}$						
Span Pressure Data	Min. to Max. $P_{opt}$		SD	-	14746	-	Count	*5
Accuracy	in Compensated Temperature		Error	-1.0	-	+1.0	%FS	*6, 7, 8
Compensated Temperature			$T_c$	-5	-	+65	$^\circ\text{C}$	*9
Supply Current	VDD = 5 Vdc		$I_c$	-	-	4.5	mAdc	*10
	VDD = 3.3, 3.0 Vdc			-	-	3.5		
Initializing Time	After VDD reaching 2.7 V		$t_{init}$	-	-	10	msec.	*11
Sampling Frequency			$f_{smp}$	-	2	-	kHz	
Response Time	for reference		$t_r$	-	1	-	msec.	*12
Temperature Data	for reference	$-5^\circ\text{C}$	$D_{tmp}$	-	461	-	Count	*13
		$+25^\circ\text{C}$		-	768	-		
		$+65^\circ\text{C}$		-	1177	-		
Dielectric Strength				-	-	1	mA	*14
Insulation Resistance				100	-	-	MQ	*15

Notes:

- \*1) Supply voltage (VDD) should be constant.
- \*2) Offset pressure data ( $D_{off}$ ) is defined as the pressure data at minimum  $P_{opt}$ . In case of Pressure type V, Offset pressure data ( $D_{off}$ ) is defined as the pressure data of maximum  $P_{opt}$ .
- \*3) Offset error is calibration error of Offset pressure data ( $D_{off}$ ) at production. It does not include Long term offset drift. It would be suggested that applications have Auto-zeroing function.
- \*4) Full scale pressure data ( $D_{fs}$ ) is defined as the pressure data at maximum  $P_{opt}$ . In case of Pressure type V, Full scale pressure data ( $D_{fs}$ ) is defined as the pressure data of minimum  $P_{opt}$ .
- \*5) Span pressure data (SD) is defined as the pressure data difference between Offset pressure data ( $D_{off}$ ) and Full scale pressure data ( $D_{fs}$ ).
- \*6) The unit of Accuracy "%FS" is defined as a percent error by Span pressure data (SD).
- \*7) Accuracy (Error) is the specs of out-going inspection at Fujikura. It consists of the following:
  - Non-linearity
  - Temperature errors over the temperature range -5 to  $65^\circ\text{C}$
  - Pressure hysteresis
  - Calibration errors of sensitivity and offset
- \*8) The following errors are NOT included to Accuracy (Error):
  - Offset change due to port orientation sensitivity, soldering thermal stress and assembling mechanical stress
  - Offset drift over time
- \*9) Please also refer to Chapter 18 Transfer Function.
- \*10) Lower power mode is available for a modification product. Please ask Fujikura.
- \*11) Initializing process starts when VDD reached 2.7 V. After initializing process, ready to data read. See the figure below.
- \*12) Response time ( $t_r$ ) is defined as the time for the change in the pressure data from 10 % to 90 % or from 90 % to 10 % of its final value when the input pressure makes a step change. Please see the figure below.
- \*13) Temperature Data ( $D_{tmp}$ ) is for reference.
- \*14) Dielectric strength is defined as the leakage current between all pins and the package with AC 500 V, 1 minute.
- \*15) Insulation resistance is defined as the resistance value between all pins and the package with DC 500 V.

### Initializing Time

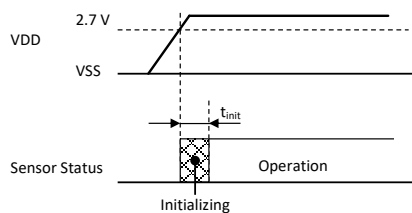

### Response Time

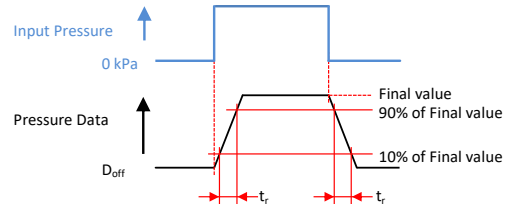

## AL4 series (Gauge Pressure Type) | V-70107C-E

## 11. Electrical Characteristics for I<sup>2</sup>C or SPI Interface

Communication interface (communication mode) of I<sup>2</sup>C or SPI is factory setting. User cannot change communication mode like from I<sup>2</sup>C to SPI or from SPI to I<sup>2</sup>C.

Ambient temperature  $T_a=25^{\circ}\text{C}$

Item	Condition	Symbol	Rating			Unit
			Min.	Typ.	Max.	
Interface			I <sup>2</sup> C or SPI			*1
Input Low Voltage	Sensor Code	AL40DB	0	-	1	V
		AL41DB	0	-	0.66	V
		AL42DB	0	-	0.6	V
Input High Voltage	Sensor Code	AL40DB	4	-	5	V
		AL41DB	2.64	-	3.3	V
		AL42DB	2.4	-	3	V
Output Low Voltage	Sensor Code	AL40DB	-	-	0.5	V
		AL41DB	-	-	0.33	V
		AL42DB	-	-	0.3	V

Notes:

\*1) I<sup>2</sup>C is a trademark of NXP Semiconductors.

## 12. I<sup>2</sup>C or SPI Circuits (Reference)

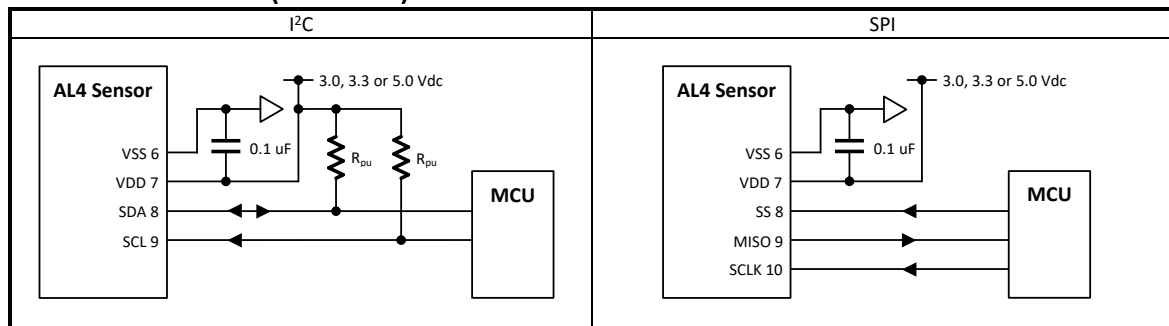



### 13. I<sup>2</sup>C Digital Interface

Item	Condition	Symbol	Rating			Unit
			Min.	Typ.	Max.	
SCL clock frequency		$f_{SCL}$	100	-	400	kHz
Start condition hold time relative to SCL edge		$t_{HDSTA}$	0.1	-	-	$\mu$ sec.
Minimum SCL clock low width		$t_{LOW}$	0.6	-	-	$\mu$ sec. *2
Minimum SCL clock high width		$t_{HIGH}$	0.6	-	-	$\mu$ sec. *2
Start condition setup time relative to SCL edge		$t_{SUSTA}$	0.1	-	-	$\mu$ sec.
Data hold time on SDA relative to SCL edge		$t_{HDDAT}$	0	-	-	$\mu$ sec.
Data setup time on SDA relative to SCL edge		$t_{SUDAT}$	0.1	-	-	$\mu$ sec.
Stop condition setup time on SCL		$t_{SUSTO}$	0.1	-	-	$\mu$ sec.
Bus free time between stop condition and start condition		$t_{BUS}$	2	-	-	$\mu$ sec.
Load Capacitance	Pin8 SDA, 400kHz	$C_{max}$	-	-	200	pF
Pull-up Resistor	Pin8 SDA, Pin9 SCL	$R_{pu}$	1	-	-	k $\Omega$
Slave address	7 bit, Factory setting		0x28 to 0x78			*3

Notes:

- \*1) There are three differences in this device protocol compared with the original I<sup>2</sup>C™ protocol:
  - Sending a start-stop condition without any transitions on the CLK line (no clock pulses in between) creates a communication error for the next communication, even if the next start condition is correct and the clock pulse is applied. An additional start condition must be sent, which results in restoration of proper communication.
  - The restart condition - a falling SDA edge during data transmission when the CLK clock line is still high - creates the same situation. The next communication fails, and an additional start condition must be sent for correct communication.
  - A falling SDA edge is not allowed between the start condition and the first rising SCL edge. If using an I<sup>2</sup>C™ address with the first bit 0, SDA must be held low from the start condition through the first bit.
- \*2) Combined low and high widths must equal or exceed minimum SCLK period.
- \*3) Slave address is factory setting. Customer cannot change the slave address.

Timing Diagram

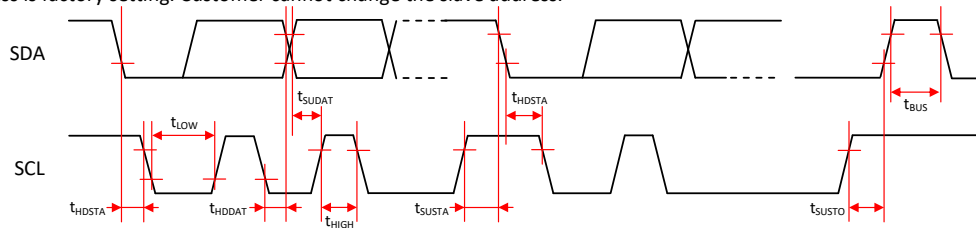

### 14. I<sup>2</sup>C Communication Protocol

Item	Measurement Packet	
Data Fetch	<p>The diagram illustrates the bit-level structure of the I<sup>2</sup>C communication. It shows a sequence of bits: Slave Address [6:0] (bits 6-0), Status Bit (R), Pressure Data [13:8] (bits 15-8), Pressure Data [7:0] (bits 7-0), Temperature Data [10:3] (bits 10-3), and Temperature Data [2:0] (bits 2-0). Arrows indicate the direction of data flow: 'From Master to Slave' for the address and status bit, and 'From Slave to Master' for the data packets. A legend on the right defines the bit values: S (Start Condition), R (Stop Condition), 6 (Slave Address), 13 (Data Bit), R (Read 1), A (ACK), and N (NACK).</p>	
Status bits	00	Normal operation , good data packet
	01	Device in Command Mode
	10	Stale data: Data has already been fetched since the last measurement cycle.
	11	EEPROM Error

Notes:

- \*1) If the status bits are 01, the device must be re-started to turn power supply off and on again.
- \*2) If a data fetch is performed before or during the first measurement after power-on reset, then “stale” will be returned, but this data is actually invalid because the first measurement has not been completed.
- \*3) If the status bits are 11, do not use the device anymore.

### 15. SPI Digital Interface

This mode is half duplex (read-only).

Item	Condition	Symbol	Rating			Unit
			Min.	Typ.	Max.	
SCLK clock frequency	4 MHz clock	$f_{SCL}$	50	-	800	kHz
SS drop to first clock edge		$t_{HDSS}$	2.5	-	-	$\mu$ sec.
Minimum SCLK clock low width		$t_{LOW}$	0.6	-	-	$\mu$ sec. *1
Minimum SCLK clock high width		$t_{HIGH}$	0.6	-	-	$\mu$ sec. *1
Clock edge to data transition		$t_{CLKD}$	0	-	0.1	$\mu$ sec.
Rise of SS relative to last clock edge		$t_{SUSS}$	0.1	-	-	$\mu$ sec.
Bus free time between rise and fall of SS		$t_{BUS}$	2	-	-	$\mu$ sec.

Notes:

\*1) Combined low and high widths must equal or exceed minimum SCLK period.

#### Timing Diagram

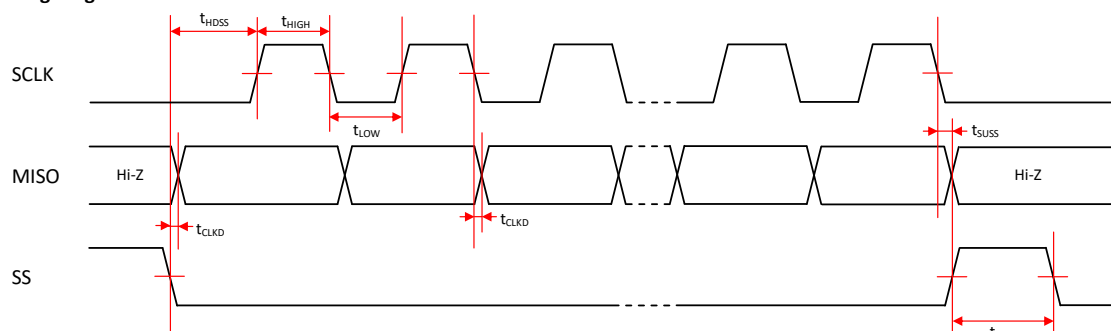

### 16. SPI Communication Protocol

The master should sample MISO on the rise of SCLK.

Item	Measurement Packet
Data Fetch	<p>SCLK </p> <p>MISO </p> <p>SS </p> <p>Packet = <math>\{S(1:0), B(13:8), \{B(7:0)\}, \{T(10:3)\}, \{T(2:0), xxxxx\}\}</math> Where                      S(1:0) = Status bits of packet (Normal, Command, Busy, EEPROM Error)                      B(13:8) = Upper 6 bits of 14-bit bridge data                      B(7:0) = Lower 8 bits of 14-bit bridge data                      T(10:3) = Corrected temperature data (if application does not require corrected temperature data, terminate read only.)                      T(2:0), xxxxx = Remaining bits of corrected temperature data for full 11-bit resolution                      Hi-Z = High impedance</p>

### 17. Output versus Input Pressure

Pressure type: G (Positive pressure)

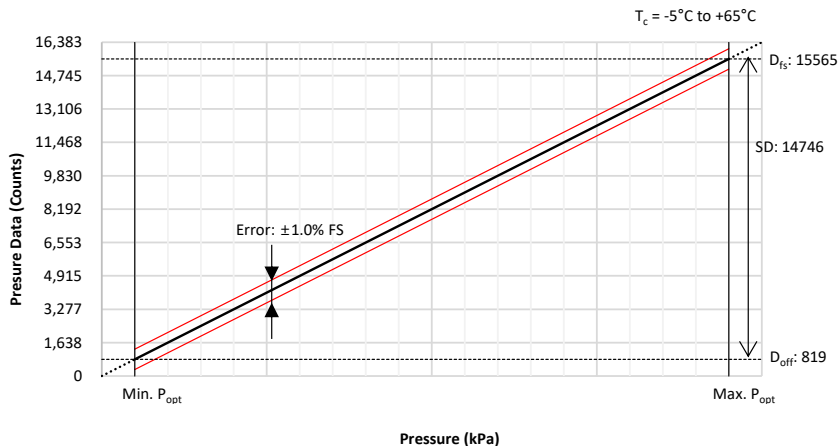

Pressure type: V (Vacuum pressure)

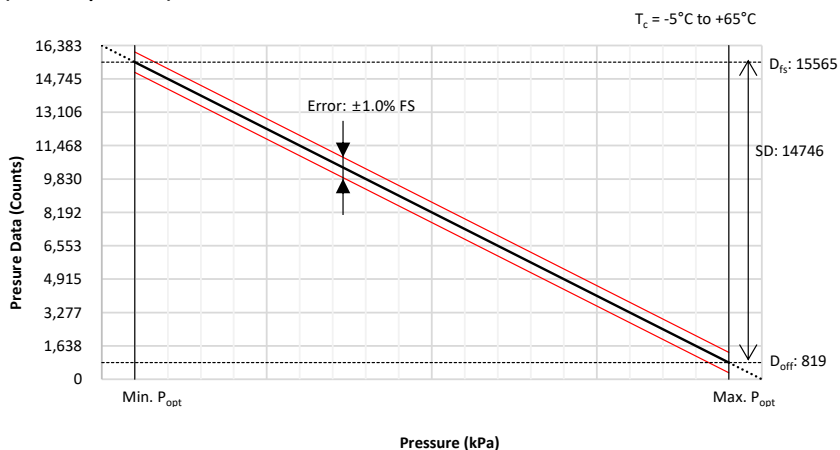

Pressure type: W (Compound pressure)

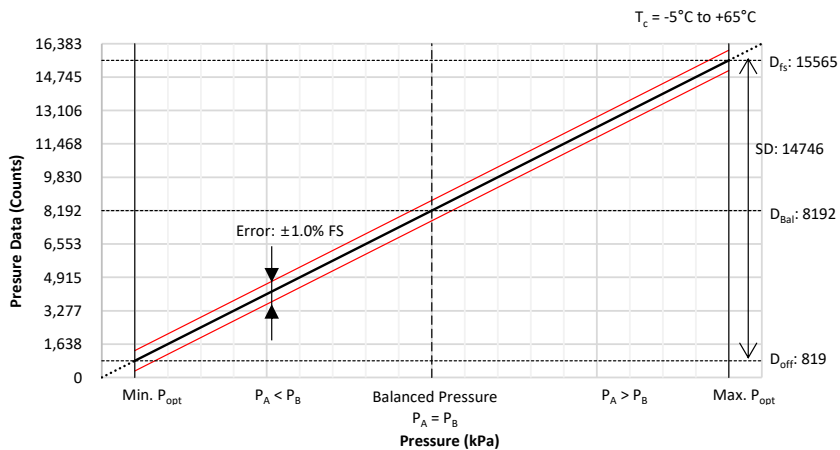

**18. Transfer Function**

Item	Transfer Function																																																																						
Pressure Data	$\text{Pressure Data (Count)} = P \times \alpha + \beta \pm (\text{Error} \times \text{Temperature Error Multiplier})$																																																																						
	$P \text{ (kPa)} = \frac{\text{Pressure Data} - \beta \pm (\text{Error} \times \text{Temperature Error Multiplier})}{\alpha}$																																																																						
	<table border="1"> <thead> <tr> <th>Pressure Code</th> <th>P (kPa)</th> <th><math>\alpha</math></th> <th><math>\beta</math></th> <th>Error</th> </tr> </thead> <tbody> <tr><td>002KG</td><td>0 to +2</td><td>7373</td><td>819</td><td>147</td></tr> <tr><td>004KG</td><td>0 to +4</td><td>7373/2</td><td>819</td><td>147</td></tr> <tr><td>007KG</td><td>0 to +7</td><td>14746/7</td><td>819</td><td>147</td></tr> <tr><td>010KG</td><td>0 to +10</td><td>7373/5</td><td>819</td><td>147</td></tr> <tr><td>002KV</td><td>-2 to 0</td><td>-7373</td><td>819</td><td>147</td></tr> <tr><td>004KV</td><td>-4 to 0</td><td>-7373/2</td><td>819</td><td>147</td></tr> <tr><td>007KV</td><td>-7 to 0</td><td>-14746/7</td><td>819</td><td>147</td></tr> <tr><td>010KV</td><td>-10 to 0</td><td>-7373/5</td><td>819</td><td>147</td></tr> <tr><td>001KW</td><td>-1 to +1</td><td>7373</td><td>8192</td><td>147</td></tr> <tr><td>002KW</td><td>-2 to +2</td><td>7373/2</td><td>8192</td><td>147</td></tr> <tr><td>004KW</td><td>-4 to +4</td><td>7373/4</td><td>8192</td><td>147</td></tr> <tr><td>007KW</td><td>-7 to +7</td><td>7373/7</td><td>8192</td><td>147</td></tr> <tr><td>010KW</td><td>-10 to +10</td><td>7373/10</td><td>8192</td><td>147</td></tr> </tbody> </table>	Pressure Code	P (kPa)	$\alpha$	$\beta$	Error	002KG	0 to +2	7373	819	147	004KG	0 to +4	7373/2	819	147	007KG	0 to +7	14746/7	819	147	010KG	0 to +10	7373/5	819	147	002KV	-2 to 0	-7373	819	147	004KV	-4 to 0	-7373/2	819	147	007KV	-7 to 0	-14746/7	819	147	010KV	-10 to 0	-7373/5	819	147	001KW	-1 to +1	7373	8192	147	002KW	-2 to +2	7373/2	8192	147	004KW	-4 to +4	7373/4	8192	147	007KW	-7 to +7	7373/7	8192	147	010KW	-10 to +10	7373/10	8192	147
Pressure Code	P (kPa)	$\alpha$	$\beta$	Error																																																																			
002KG	0 to +2	7373	819	147																																																																			
004KG	0 to +4	7373/2	819	147																																																																			
007KG	0 to +7	14746/7	819	147																																																																			
010KG	0 to +10	7373/5	819	147																																																																			
002KV	-2 to 0	-7373	819	147																																																																			
004KV	-4 to 0	-7373/2	819	147																																																																			
007KV	-7 to 0	-14746/7	819	147																																																																			
010KV	-10 to 0	-7373/5	819	147																																																																			
001KW	-1 to +1	7373	8192	147																																																																			
002KW	-2 to +2	7373/2	8192	147																																																																			
004KW	-4 to +4	7373/4	8192	147																																																																			
007KW	-7 to +7	7373/7	8192	147																																																																			
010KW	-10 to +10	7373/10	8192	147																																																																			
Temperature Data	$D_{\text{tmp}} \text{ (Count)} = \frac{2047}{200} \times (T + 50) \quad \longleftrightarrow \quad T \text{ (}^\circ\text{C)} = \frac{200}{2047} \times D_{\text{tmp}} - 50$																																																																						

### 19. Device Marking

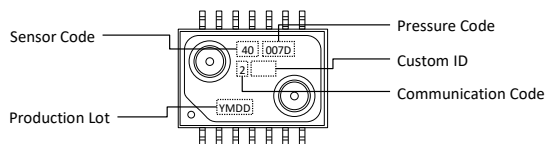

Production Lot *1	Sensor Code		Pressure Code		Communication Code		Custom ID Marking
	Marking	Marking	Marking	Marking	Marking	Marking	
Y: Last digit of year	0 to 9	AL40DB 40	002KG 002K	2	2	If applicable	
M: Month Jan. to Sep.	1 to 9	AL41DB 41	004KG 004K	3	3		
October	X	AL42DB 42	007KG 007K	4	4		
November	Y		010KG 010K	5	5		
December	Z		002KV 002V	6	6		
DD: Date	00 to 31		004KV 004V	7	7		
			007KV 007V	S	S		
			010KV 010V				
			001KW 001W				
			002KW 002W				
			004KW 004W				
			007KW 007W				
			010KW 010W				

Notes:

- \*1) Port option is not marked on the package.
- \*2) Custom ID will be added when product is customized for a customer.

### 20. Soldering

Items	Condition																		
Moisture Sensitivity Level	Level 1																		
Reflow Soldering Profile	<table border="1" style="margin-left: 20px;"> <thead> <tr> <th>Stage</th> <th>Description</th> <th>Temperature / Time</th> </tr> </thead> <tbody> <tr> <td>A</td> <td>Ramp up</td> <td>2 to 4°C / sec.</td> </tr> <tr> <td>B</td> <td>Pre-heating</td> <td>150 to 180°C, 60 to 120 sec.</td> </tr> <tr> <td>C</td> <td>Ramp up</td> <td>2 to 4°C / sec.</td> </tr> <tr> <td>D</td> <td>Heating</td> <td>Above 230°C, 45 sec. max. 245°C max., 10 sec. max.</td> </tr> <tr> <td>E</td> <td>Ramp down</td> <td>2 to 4°C / sec.</td> </tr> </tbody> </table>	Stage	Description	Temperature / Time	A	Ramp up	2 to 4°C / sec.	B	Pre-heating	150 to 180°C, 60 to 120 sec.	C	Ramp up	2 to 4°C / sec.	D	Heating	Above 230°C, 45 sec. max. 245°C max., 10 sec. max.	E	Ramp down	2 to 4°C / sec.
Stage	Description	Temperature / Time																	
A	Ramp up	2 to 4°C / sec.																	
B	Pre-heating	150 to 180°C, 60 to 120 sec.																	
C	Ramp up	2 to 4°C / sec.																	
D	Heating	Above 230°C, 45 sec. max. 245°C max., 10 sec. max.																	
E	Ramp down	2 to 4°C / sec.																	

Notes:

- \*1) This device is classified as moisture sensitivity level (MSL) 1 that is defined in Jedec standard J-STD-20. Floor life time is unlimited. However, the plating of pins is silver (Ag) that could be discolored to black or brown by sulfur in the environment. Discoloration of pins could impact soldering reliability. The device should be sealed in the embossed carrier tape before soldering.
- \*2) NEVER wash the device with any washing liquid. NEVER wash the device with any ultrasonic washing machine.
- \*3) Do not put the solder and flux on the device's package.
- \*4) Temperature means Surface temperature of the device's package.
- \*5) Do not reflow more than twice.

### 21. Dimensions and Weights

Refer to the following drawing as attached. 3D CAD model is available. Please ask Fujikura distributor.

Sensor Code	Dimension Drawing	Weight
AL4xDB	9-772-006	approx. 0.55 grams

## 22. Ordering Information

Model	Package	Supply Voltage	Packing	Ordering Device Number	Qty./Packing
AL4	SMD	5.0 Vdc	Tape & Reel	AL40DB-[Pressure Code]-[Com Code]-TP	350 Pcs/Reel
		3.3 Vdc	Tape & Reel	AL41DB-[Pressure Code]-[Com Code]-TP	350 Pcs/Reel
		3.0 Vdc	Tape & Reel	AL42DB-[Pressure Code]-[Com Code]-TP	350 Pcs/Reel

Pressure Range	Pressure Code
0 to +2 kPa	002KG
0 to +4 kPa	004KG
0 to +7 kPa	007KG
0 to +10 kPa	010KG
-2 to 0 kPa	002KV
-4 to 0 kPa	004KV
-7 to 0 kPa	007KV
-10 to 0 kPa	010KV
-1 to +1 kPa	001KW
-2 to +2 kPa	002KW
-4 to +4 kPa	004KW
-7 to +7 kPa	007KW
-10 to +10 kPa	010KW

Communication Code		
I <sup>2</sup> C Slave address	0x28	2
	0x38	3
	0x48	4
	0x58	5
	0x68	6
SPI		S

I2C or SPI is factory setting.  
User cannot change the communication mode.

## 23. Tape & Reel Information

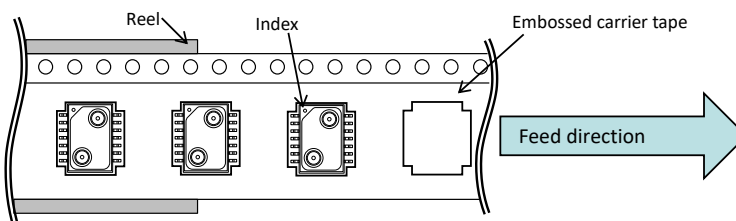

## 24. Handling Notes

Plating of pins is silver (Ag). Silver has physical property that is discolored to black or brown by sulfur. There are notes for handling as below:

- To prevent discoloration of pins, please keep the devices sealed in static shielding bags before soldering.
- Do not solder the devices that have discolored pins.
- After soldering, pins would be discolored in black or brown in atmosphere. However it does not impact reliability of the device.

## 25. Notes

- Fujikura reserves all rights.
- This document is subject to change without notice.
- Limitation, usage, environment, standard warranty and so on are listed on Fujikura web site.
- Please refer to the latest specifications.

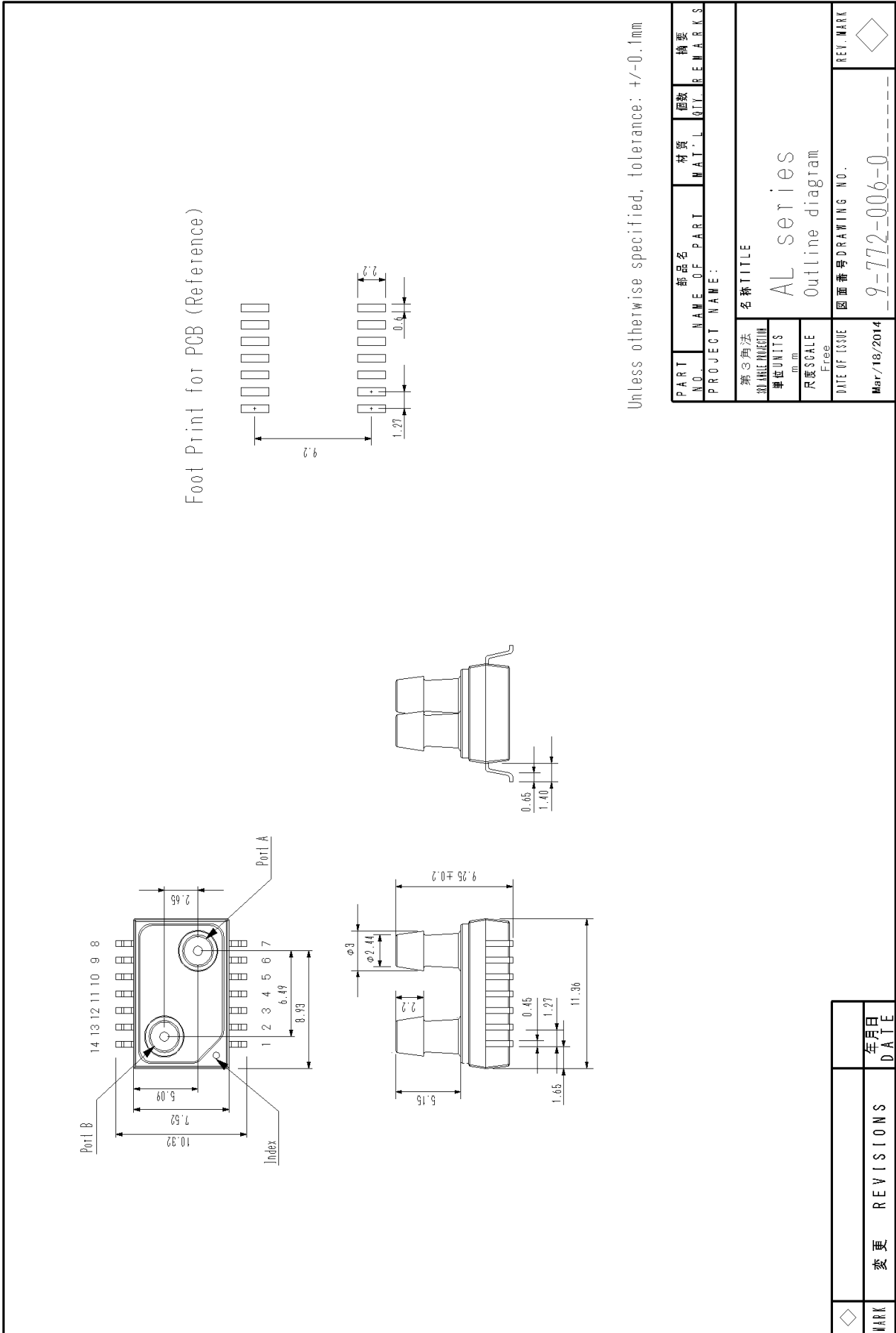

Unless otherwise specified, tolerance: +/-0.1mm

PART NO.	部品名	材質	個數	摘要
NAME OF PART	MATL	QTY	REMARKS	
PROJECT NAME:				
名稱 TITLE				
AL series				
Outline diagram				
第3角法				
SCALE				
DATE OF ISSUE				
Mar/18/2014				
圖面番號 DRAWING NO.				
9-772-006-0				
REV. MARK				

年	月	日
DATE		
變更	REVISIONS	
MARK		

Headquarter Switzerland:  
Pewatron AG  
Thurgauerstrasse 66  
CH-8050 Zurich  
Phone +41 44 877 35 00  
info@pewatron.com

Office Germany:  
Pewatron Deutschland GmbH  
Edisonstraße 16  
D-85716 Unterschleißheim  
Phone +49 89 374 288 87 00  
info.de@pewatron.com



**PEWATRON**  
SENSORS · POWER SOLUTIONS

## We are here for you. Addresses and Contacts.

---

### Sales Germany & Austria

#### Geometrical sensors Other products

Kurt Stritzelberger  
Phone +49 89 374 288 87 22  
kurt.stritzelberger@pewatron.com

#### Pressure sensors Other products

Gerhard Vetter  
Phone +49 89 374 288 87 26  
gerhard.vetter@pewatron.com

#### Gas sensors and modules

Peter Felder  
Phone +41 44 877 35 05  
peter.felder@pewatron.com

---

### Sales Switzerland & Liechtenstein

Postcode 3000 – 9999

Basil Frei  
Phone +41 44 877 35 18  
basil.frei@pewatron.com

Postcode 1000 – 2999

Christian Mohrenstecher  
Phone +41 76 444 57 93  
christian.mohrenstecher@pewatron.com

### Sales International Key Accounts

Peter Felder  
Phone +41 44 877 35 05  
peter.felder@pewatron.com

---

### Sales Other Countries / Product Management

#### Pressure Sensors Load Cells

Philipp Kistler  
Phone +41 44 877 35 03  
philipp.kistler@pewatron.com

#### Gas sensors Gas sensor modules

Dr. Thomas Clausen  
Phone +41 44 877 35 13  
thomas.clausen@pewatron.com

#### Flow / Level / Medical products

Dr. Adriano Pittarelli  
Phone +49 89 374 288 87 67  
adriano.pittarelli@pewatron.com

#### Power supplies

Sebastiano Leggio  
Phone +41 44 877 35 06  
sebastiano.leggio@pewatron.com

#### Linear position sensors Angle sensors

Eric Letsch  
Phone +41 44 877 35 14  
eric.letsch@pewatron.com

#### Accelerometers Sensor elements

Christoph Kleye  
Phone +49 89 374 288 87 61  
christoph.kleye@pewatron.com

#### Drive technology

CH Postcode 5000 – 9999 / DE

Roman Homa  
Phone +41 76 444 00 86  
roman.homa@pewatron.com

#### Drive technology

CH Postcode 1000 – 4999 / AT / IT / FR

Christian Mohrenstecher  
Phone +41 76 444 57 93  
christian.mohrenstecher@pewatron.com

#### Harald Thomas

Phone +49 89 374 288 87 23  
harald.thomas@pewatron.com