

Analog Output (Non-Digitally Corrected) & Single Point Pressure Threshold Detection Semiconductor Pressure Sensor

AP3 Series

Description

The AP3 pressure sensor series is composed of a silicon piezoresistive pressure sensing chip and a signal conditioning integrated circuit. The signal conditioning IC does not have A/D and D/A converter in a gain amplifier. Therefore the AP3 series can provide full analog amplified and temperature compensated output. Moreover the amplification circuit is designed with low noise output. As a unique function, the AP3 series has Single Point Pressure Threshold Detection. Analog output and threshold voltage are supplied to an internal comparator that compares two voltages and outputs a comparison result as digital output.

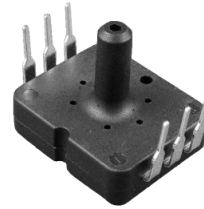

AP3*N

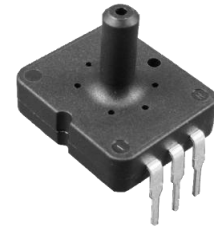

AP3*R

Features

- Non-digitally amplified and temperature compensated analog output
- Single point pressure threshold detection
- High accuracy $\pm 1.5\%FS$ / 0 to $+60^\circ C$
- Supply voltage 3.0, 3.3 & 5.0 Vdc
- Package compatible with Fujikura's XFPM integrated pressure sensor
- Customization or modification available

Applications

- Medical devices
- Industrial pneumatic devices
- Consumer devices

✓ RoHS Compliant

Device Lineup

Model	Pin Direction	Pressure Type	Supply Voltage	Accuracy	Pressure Range										
					-100	-50	0	25	50	100	200	500	700	1000 kPa	
					(-15)	(-7)		(3)	(7)	(15)	(30)	(70)	(100)	(150) psi	
AP3	Normal or Opposite	Gauge	5.0 Vdc	$\pm 1.5\%FS$											
			3.3 Vdc		3.0 Vdc	$\pm 2.0\%FS$	Same as the above								

© 2014 Fujikura Ltd. All rights reserved.
 This data sheet has a possibility to be revised without notice. This data sheet does not contain all information. Before designing, please ask us the specifications of this product.



Analog Output (Non-Digitally Corrected) & Single Point Pressure Threshold Detection Semiconductor Pressure Sensor

AP3 Series

Device Name Code

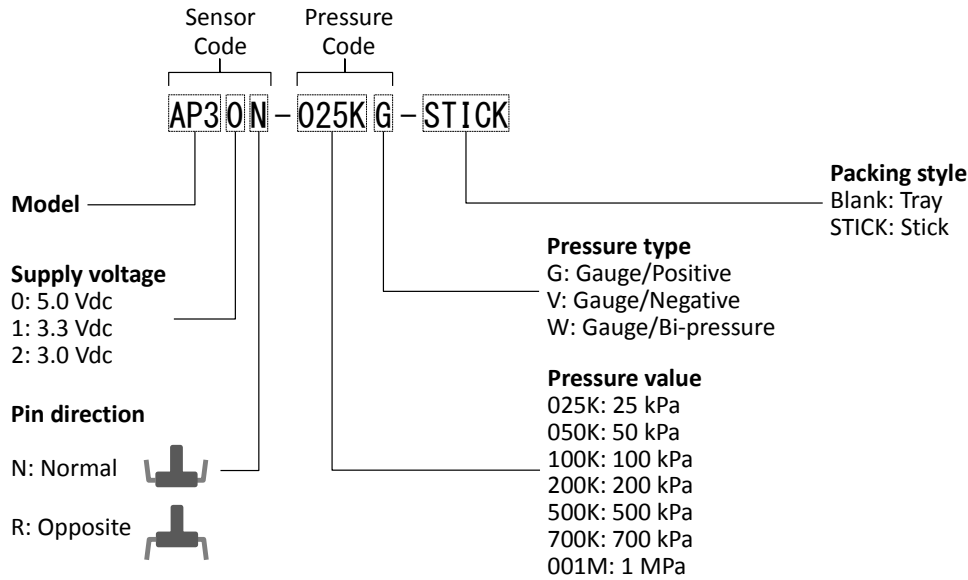

Block Diagram

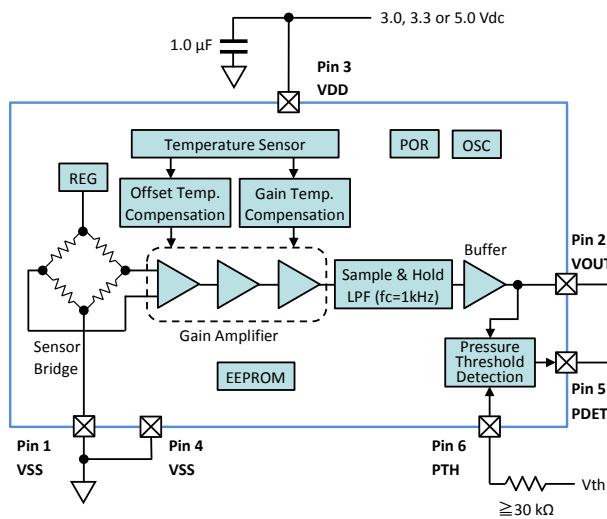

Output Characteristics

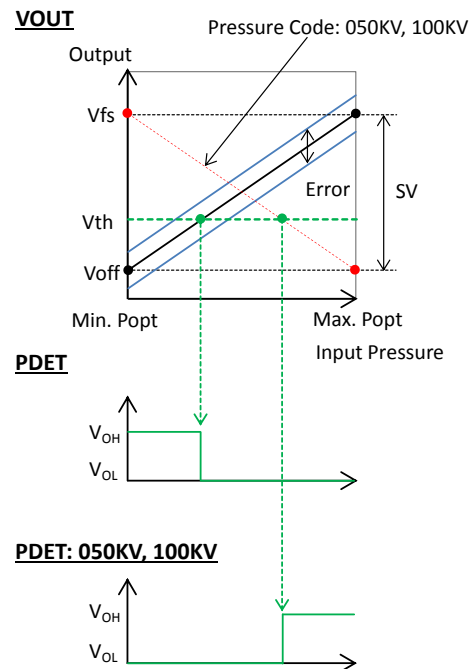

© 2014 Fujikura Ltd. All rights reserved.
 This data sheet has a possibility to be revised without notice. This data sheet does not contain all information. Before designing, please ask us the specifications of this product.



Analog Output (Non-Digitally Corrected) & Single Point Pressure Threshold Detection Semiconductor Pressure Sensor

AP3 Series

Absolute Maximum Ratings

Item	Symbol	Rating	Unit
Supply Voltage	VDDmax	6	Vdc
Input Voltage	VIN	VSS - 0.3 to VDD + 0.3	V
Load Pressure	Pmax+	See Pressure Range Table	
Operating Temperature	Topt	-40 to +105	°C
Storage Temperature	Tstg	-40 to +105	°C

General Specifications

Item	Symbol	Sensor Code			Unit
		AP30*	AP31*	AP32*	
Supply Voltage	VDD	5.0±0.25	3.3±0.165	3.0±0.15	Vdc
Type of Pressure	-	Gauge pressure			
Pressure Media	-	Non-corrosive gases			
Compensated Temperature	-	0 to +60			°C
Operating Humidity	Hopt	30 to 85 (non-condensing)			%RH
Storage Humidity	Hstg	30 to 85 (non-condensing)			%RH

Pressure Range

Item	Symbol	Pressure Code										Unit
		025KG	050KG	100KG	200KG	500KG	700KG	001MG	050KV	100KV	100KW	
Absolute Maximum Load Pressure	Pmax+	+50	+100	+200	+400	+1000	+1400	+1500	+100	+200	+200	kPa
Measurement Pressure	Popt	Min. 0	0	0	0	0	0	0	-50	-100	-100	
		Max. +25	+50	+100	+200	+500	+700	+1000	0	0	+100	

Electrical Characteristics

Load resistor $R_L = \infty$, Ambient temperature $T_a = 25^\circ\text{C}$

Sensor Code	Item	Condition	Symbol	Rating			Unit	
				Min.	Typ.	Max.		
AP30* VDD = 5.0 Vdc	Offset Voltage	Min. Popt, 050KV & 100KV: Max. Popt	Voff	0.1325	0.2	0.2675	V	
	Full Scale Voltage	Max. Popt, 050KV & 100KV: Min. Popt	Vfs	4.6325	4.7	4.7675	V	
	Span Voltage	Min. to max. Popt	SV	-	4.5	-	V	
	Accuracy	0 to 60°C	Error	-1.5	-	+1.5	%FS	
				-0.0675	-	+0.0675	V	
	Supply Current		Ic	-	-	6	mAdc	
AP31* VDD = 3.3 Vdc	Offset Voltage	Min. Popt, 050KV & 100KV: Max. Popt	Voff	0.2595	0.3	0.3405	V	
	Full Scale Voltage	Max. Popt, 050KV & 100KV: Min. Popt	Vfs	2.9595	3.0	3.0405	V	
	Span Voltage	Min. to max. Popt	SV	-	2.7	-	V	
	Accuracy	0 to 60°C	Error	-1.5	-	+1.5	%FS	
				-0.0405	-	+0.0405	V	
	Supply Current		Ic	-	-	5	mAdc	
AP32* VDD = 3.0 Vdc	Offset Voltage	Min. Popt, 050KV & 100KV: Max. Popt	Voff	0.096	0.15	0.204	V	
	Full Scale Voltage	Max. Popt, 050KV & 100KV: Min. Popt	Vfs	2.796	2.85	2.904	V	
	Span Voltage	Min. to max. Popt	SV	-	2.7	-	V	
	Accuracy	0 to 60°C	Error	-2.0	-	+2.0	%FS	
				-0.054	-	+0.054	V	
	Supply Current		Ic	-	-	5	mAdc	
Pressure Threshold Detection	Type of Output		PDET	CMOS				
	Threshold Input to PTH		Vth	0.1 x VDD	-	0.9 x VDD	V	
	Input Impedance of PTH		Zin	1	-	-	MΩ	
	Output from PDET	VOU < Vth	Error	VOH	0.9 x VDD	-	-	V
				VOL	-	-	0.1 x VDD	V
	Pressure Hysteresis		Phys	-	0.05 x VDD	-	V	
	Common	Response Time	for reference	tr	-	2	-	msec.
Load Resistor		VOU - VSS or VDD - VOUT	RL	9.5	-	-	kΩ	
Load Capacitance		VOU - VSS	CL	-	-	50	nF	

© 2014 Fujikura Ltd. All rights reserved.

This data sheet has a possibility to be revised without notice. This data sheet does not contain all information. Before designing, please ask us the specifications of this product.



Analog Output (Non-Digitally Corrected) & Single Point Pressure Threshold Detection Semiconductor Pressure Sensor

AP3 Series

Package Dimensions

unit: mm

Sensor Code: AP3*N

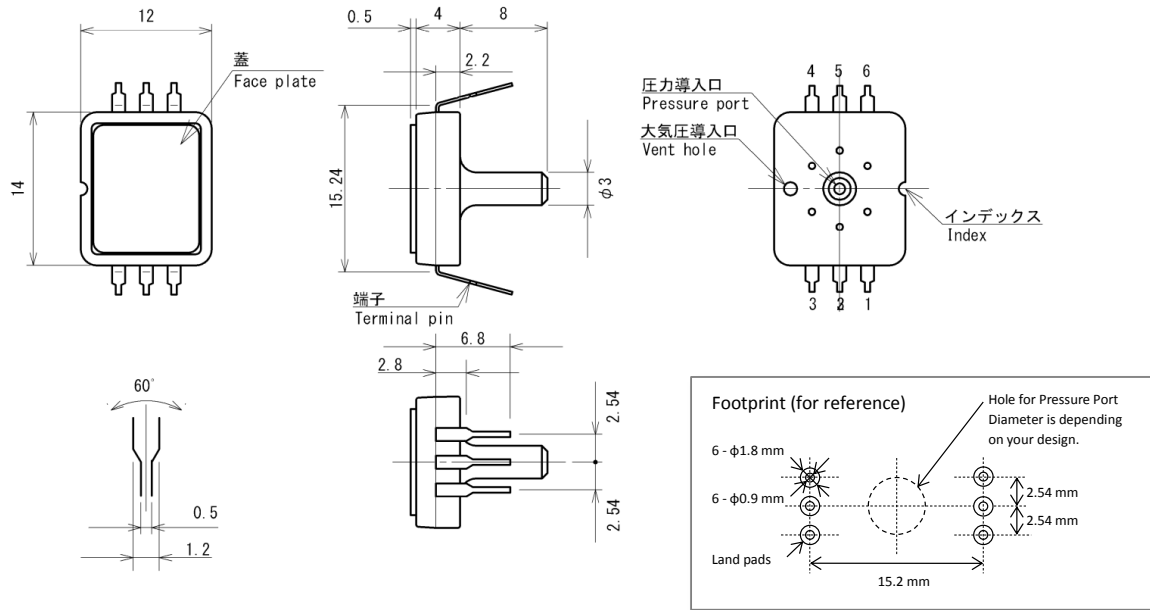

Sensor Code: AP3*R

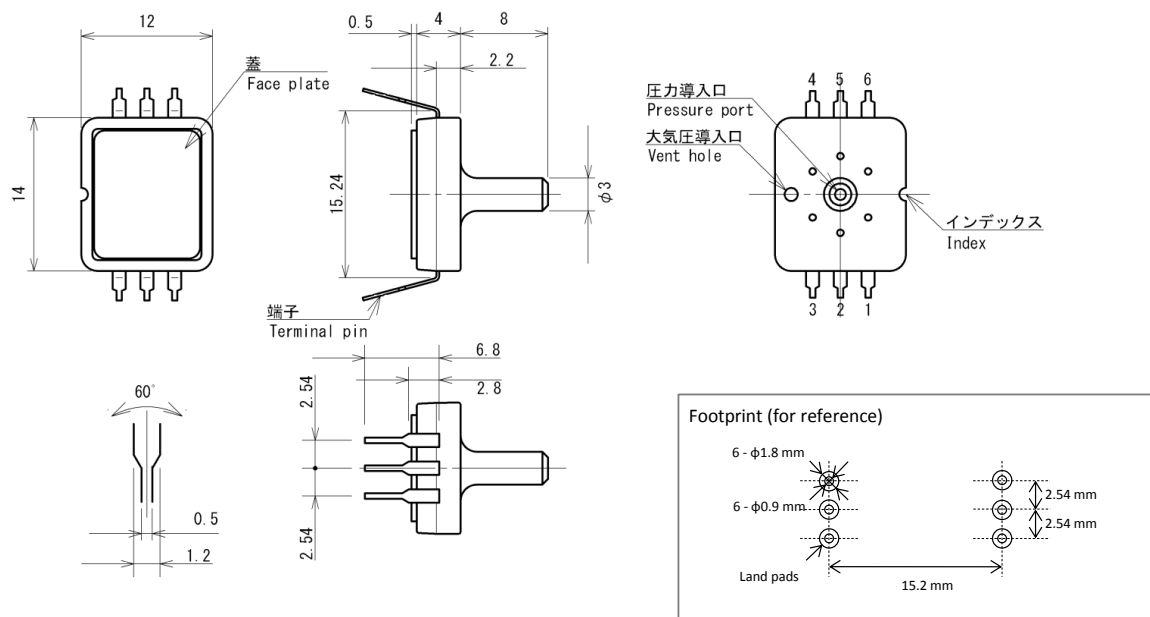

© 2014 Fujikura Ltd. All rights reserved.
 This data sheet has a possibility to be revised without notice. This data sheet does not contain all information. Before designing, please ask us the specifications of this product.



Headquarter Switzerland:
Pewatron AG
Thurgauerstrasse 66
CH-8050 Zurich
Phone +41 44 877 35 00
info@pewatron.com

Office Germany:
Pewatron Deutschland GmbH
Edisonstraße 16
D-85716 Unterschleißheim
Phone +49 89 374 288 87 00
info.de@pewatron.com



PEWATRON
SENSORS · POWER SOLUTIONS

We are here for you. Addresses and Contacts.

Sales Germany & Austria

Geometrical sensors Other products

Kurt Stritzelberger
Phone +49 89 374 288 87 22
kurt.stritzelberger@pewatron.com

Pressure sensors Other products

Gerhard Vetter
Phone +49 89 374 288 87 26
gerhard.vetter@pewatron.com

Gas sensors and modules

Peter Felder
Phone +41 44 877 35 05
peter.felder@pewatron.com

Sales Switzerland & Liechtenstein

Postcode 3000 – 9999

Basil Frei
Phone +41 44 877 35 18
basil.frei@pewatron.com

Postcode 1000 – 2999

Christian Mohrenstecher
Phone +41 76 444 57 93
christian.mohrenstecher@pewatron.com

Sales International Key Accounts

Peter Felder
Phone +41 44 877 35 05
peter.felder@pewatron.com

Sales Other Countries / Product Management

Pressure Sensors Load Cells

Philipp Kistler
Phone +41 44 877 35 03
philipp.kistler@pewatron.com

Gas sensors Gas sensor modules

Dr. Thomas Clausen
Phone +41 44 877 35 13
thomas.clausen@pewatron.com

Flow / Level / Medical products

Dr. Adriano Pittarelli
Phone +49 89 374 288 87 67
adriano.pittarelli@pewatron.com

Power supplies

Sebastiano Leggio
Phone +41 44 877 35 06
sebastiano.leggio@pewatron.com

Linear position sensors Angle sensors

Eric Letsch
Phone +41 44 877 35 14
eric.letsch@pewatron.com

Accelerometers Sensor elements

Christoph Kleye
Phone +49 89 374 288 87 61
christoph.kleye@pewatron.com

Drive technology

CH Postcode 5000 – 9999 / DE

Roman Homa
Phone +41 76 444 00 86
roman.homa@pewatron.com

Drive technology

CH Postcode 1000 – 4999 / AT / IT / FR

Christian Mohrenstecher
Phone +41 76 444 57 93
christian.mohrenstecher@pewatron.com

Harald Thomas

Phone +49 89 374 288 87 23
harald.thomas@pewatron.com